



FAIRHAVEN 10x10 PERGOLA

Model # 2101531

Owner's Manual & Assembly Instructions

MANUFACTURED BY:
Backyard Discovery
3305 Airport Drive
Pittsburg, KS 66762
800-856-4445



INSTALLATION SERVICES AVAILABLE!*

Need a helping hand?

Let our team of professionals handle the installation for you!

GOCONFIGURE
888-888-5424

*Installation services are only available to U.S. customers.

average 2 person assembly time



assembly time may vary based on skill level

Before you begin

FOR QUICK & EASY ASSEMBLY

FIND 3D INSTRUCTIONS FOR THIS PRODUCT IN

BILT.

DOWNLOAD THE FREE APP



For the most up to date assembly manual, to register your set, or to order replacement parts please visit www.backyarddiscovery.com

SAVE THIS ASSEMBLY MANUAL FOR FUTURE REFERENCE IN THE EVENT THAT YOU NEED TO ORDER REPLACEMENT PARTS.

Para obtener instrucciones en español, visite www.backyarddiscovery.com



GOCONFIGURE
Putting it all together for you

INSTALLATION SERVICES AVAILABLE!*

Need a helping hand?

Let our team of professionals handle the installation for you!

GOCONFIGURE
888-888-5424

**Installation services are only available
to U.S. customers.*

With Go Con! gure, we bring you 18 years of experience right to your doorstep. We service a wide array of indoor and outdoor recreation products that most consumers don't have the time or ability to deliver & install themselves.

We do the heavy lifting, so you don't have to!

-
- 18+ Years of Experience Servicing Big Box Retailers and Direct Consumers
 - Highly Skilled, Specialized, Courteous, Professional Service Technicians
 - Over 140,000 Installations Annually
 - White Glove Service

- Satisfaction Guarantee
 - Flexible Appointments, including weekends
 - Coverage across the nation
- Visit www.goconfigure.com for more info!**

**Installation services are only available to U.S. customers.*



The store where you made your purchase does not stock parts for this item. If you have assembly questions or you are missing or have damaged parts, please call

1-800-856-4445

you can also visit www.backyarddiscovery.com
or e-mail customerservice@backyarddiscovery.com

Please have the following information ready when you make your call:

- Model Number of the product located on the front of the assembly manual
 - The item description and number from the parts list from the manual that was included in your box
-
- Read entire assembly manual, paying special attention to the important tips and safety information.
 - Ensure there are no missing pieces by first separating and identifying all parts.
 - Make sure to check packing material for small parts that may have fallen out during shipment.
 - Structures are not intended for public use. Any unintended use such as home child care, daycare center, faith center, government facility, home owner's associate, park or school will make the warranty of our product null & void.
 - This manual contains helpful information concerning assembly preparation, installation procedure and required maintenance.
 - Always keep safety in mind as your structure is being built.
 - Keep these instructions for future reference.



THE MANUFACTURER RESERVES THE RIGHT TO MAKE SUBSTITUTIONS TO WARRANTY CLAIMS IF PARTS ARE UNAVAILABLE OR OBSOLETE

This Limited Warranty by Backyard Discovery applies to products manufactured under the Backyard Discovery brand or its other brands, including but not limited to, Adventure Playsets and Leisure Time Products.

Backyard Discovery Wood Patio Structure

Backyard Discovery warrants this wood patio product to be free from defects in materials and workmanship for a period of two (2) years from the original date of purchase. All wood carries a five (5) year warranty against rot and decay from the original purchase date. LIMITED WARRANTY

OUTDOOR PATIO ITEMS

THE MANUFACTURER RESERVES THE RIGHT TO MAKE SUBSTITUTIONS TO WARRANTY CLAIMS IF PARTS ARE UNAVAILABLE OR OBSOLETE

This Limited Warranty by Backyard Discovery applies to products manufactured under the Backyard Discovery brand or its other brands, including but not limited to, Adventure Playsets and Leisure Time Products.

Backyard Discovery Wood Patio Structure

Backyard Discovery warrants this wood patio product to be free from defects in materials and workmanship for a period of two (2) years from the original date of purchase. All wood carries a five (5) year warranty against rot and decay from the original purchase date.

Backyard Discovery Metal Patio Structure

Backyard Discovery warrants this metal patio product to be free from defect in materials and workmanship for a period of five (5) years from the original date of purchase.

General Warranty Information

This warranty applies to the original owner and registrant and is non-transferable. Regular maintenance is required to ensure maximum life and performance of this product. Failure by the owner to maintain the product according to the maintenance requirements may void this warranty. Maintenance guidelines are provided in the Owner's Manual.

This Limited Warranty does not cover:

Backyard Discovery Metal Patio Structure

Backyard Discovery warrants this metal patio product to be free from defect in materials and workmanship for a period of five (5) years from the original date of purchase.

General Warranty Information

This warranty applies to the original owner and registrant and is non-transferable. Regular maintenance is required to ensure maximum life and performance of this product. Failure by the owner to maintain the product according to the maintenance requirements may void this warranty. Maintenance guidelines are provided in the Owner's Manual.

This Limited Warranty does not cover:

- Natural occurring properties of wood such as twisting, warping, checking, peeling or any other natural occurring properties of wood that do not affect performance or integrity.
- Installation – the warranty is null and void if installation is not in accordance with the Assembly Instructions.
- Labor for any inspection
- Labor for replacement of any defective item(s)
- Incidental or consequential damages
- Cosmetic defects, including rusting, color fading, minor cracks, corrosion, which do not affect performance or integrity of a part or the entire product.
- Vandalism, improper use, failure due to loading or use beyond the capacities stated in the applicable Assembly Manual.
- Acts of nature including but not limited to wind, storms, hail, floods, excessive water exposure.
- Improper installation including but not limited to installation on uneven, unlevel, or soft ground.

Backyard Discovery products have been designed for safety and quality. Any modifications made to the original product could damage the structural integrity of the unit leading to failure and possible injury. Modification voids any-and-all warranties and Backyard Discovery assumes no liability for the modified products or consequences resulting from failure of a modified product. Backyard Discovery disclaims all other representations and warranties of any kind, express or implied.

USA and Canada: To make a warranty or replacement part claim please visit backyarddiscovery.com or call Backyard Discovery customer service at **800-856-4445**. Backyard Discovery will, at its sole discretion, replace any part within the stated warranty period that is defective in workmanship or materials. At Backyard Discovery's discretion, photographs of the defective part, physical return of the defective part to Backyard Discovery, or proof of purchase may be required for verification.

Outside of the USA and Canada: Contact place of purchase or distributor for warranty service.

This Warranty gives you specific legal rights. You may have other rights as well which vary from state to state, province to province or country to country, where you bought the product. This warranty excludes all consequential damages however, some states do not allow the limitation or exclusion of consequential damages and therefore this limitation may not apply to you.

Please read entire booklet completely before beginning the assembly process

Please retain these instructions and your receipt for future reference. Keep them in a safe place where you can refer to them as needed. In order to provide you with the most efficient service, it is required that you provide us with the part numbers when ordering parts.

For Your Records:

Please take time and fill out the information below. This information will be needed for warranty issues.

Where Purchased: _____
 Date of Purchase: _____
 Installation Date: _____
 Installed by: _____
 Tracking Number: _____

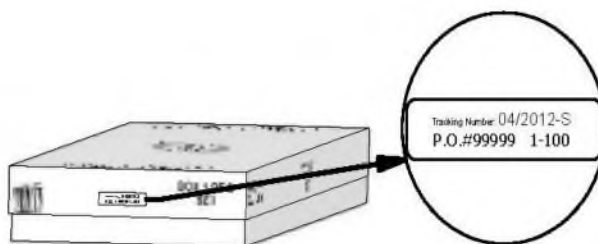

Tracking Number Reference Label

Tracking ID number on the carton is included for tracking purposes associated with warranty claims.



WARNING

IT IS IMPORTANT TO CHECK AND TIGHTEN ALL HARDWARE AT THE BEGINNING AND DURING THE SEASON AS THEY MAY LOOSEN DUE TO WOOD EXPANSION AND CONTRACTION.

- **DO NOT climb or walk on the roof for any reason**
- **Requires two or more people to assemble safely**
- **Check for underground utilities before digging or driving stakes into the ground.**
- **Check carefully for overhead lines and ensure there is at least 6ft (2m) clearance from any overhead electrical wires.**
- **Permanent structures may require a building permit. As the purchaser and or installer of this product you are advised to consult local planning, zoning and building inspection departments for guidance on applicable building codes and/or zoning requirements.**
- Wood is NOT flame retardant and will burn. Grills, fire pits and chimineas are a fire hazard if placed too close to your structure.
- Wear gloves to avoid injury during installation.
- During installation, follow all safety warnings provided with your tools and use safety glasses.
- Check all nuts and bolts twice monthly during the usage season and tighten as required. (But not so tight that you crack the wood) It is particularly important that this procedure be followed at the beginning of each season.
- Oil all metallic moving parts monthly during the usage period.
- Check all coverings for bolts and sharp edges twice monthly during usage season to be certain they are in place. Replace when necessary. It is especially important to do this at the beginning of each new season.
- For rusted areas on metallic members such as hinges, brackets, etc. sand and repaint, using a non lead-based paint meeting the requirements of Title 16 CRF Part 1303.
- Inspect wood parts monthly. The grain of the wood sometimes will lift in the dry season causing splinters to appear. Light sanding may be necessary to maintain a safe environment. Treating your Product with protection (sealant) after sanding will help prevent severe checking/splitting and other weather damage.
- We have applied a waterborne translucent stain to your unit. This is done for color only. Once or twice a year, depending on your climate conditions, you must apply some type of protection (sealant) to the wood of your unit. Prior to the application of sealant, lightly sand any "rough" spots on your set. Please note this is a requirement of your warranty.

OWNERS SHALL BE RESPONSIBLE FOR MAINTAINING THE LEGIBILITY OF THE WARNING LABELS



Protrusion Hazard

Incorrect

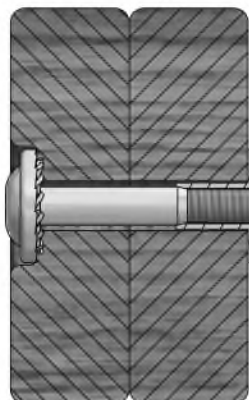

If you see exposed threads and your bolt protrudes beyond the T-Nut you may have over tightened the bolt or used incorrect hardware. If you've overtightened, remove the bolt and add washers to eliminate the protrusion.

Correct

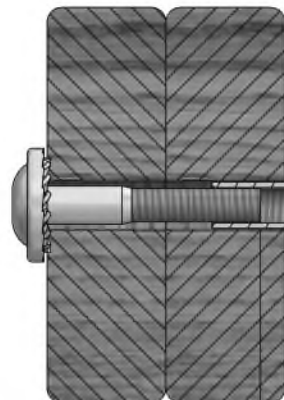

1/8"

Proper Hardware Assembly

Bolt and T-Nut Assembly

Tap T-nut into the provided hole. Insert your bolt through the lock washer and insert into the provided hole opposite from the T-Nut. Turn clockwise to thread into T-nut. Do not completely tighten until instructed.

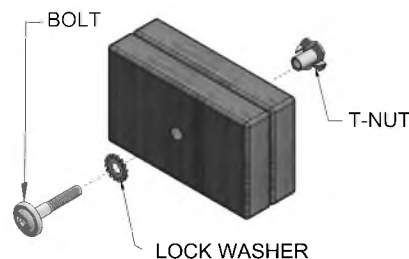

Bolt and Barrel Nut Assembly

Insert barrel nut through the lock washer and press the pair through the provided hole. Insert your bolt through the second lock washer and insert the pair into the provided hole opposite from the barrel nut. Turn clockwise to thread into the barrel nut. Do not completely tighten until instructed.

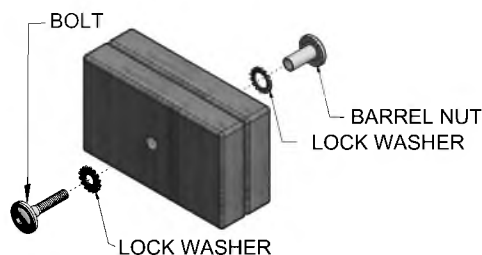

Lag Assembly

Normally there will be a pre-drilled pilot hole on assemblies that require a Lag Screw. If there is no pilot hole, line up the two boards as they are to be attached and use the factory drilled hole as a guide to drill another pilot hole into the adjoining board. This will keep the wood from splitting. Only a lock washer is required for steps with Lag Screws.

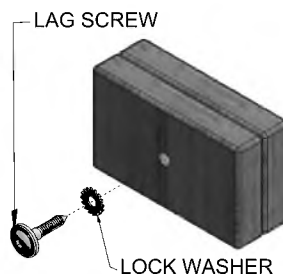



ASSEMBLY TIP:

Keep and eye out for these boxes which will contain helpful pictures and information making the assembly process as quick and painless as possible.

Sorting Wood



When removing the wood from the boxes we recommend arranging them by part number before you begin assembly. This will allow for faster assembly and easily identify any parts that may be missing or damaged.

Sorting Hardware

NUT BARREL
H100545



SCREW
H100695



T-NUT
H100699



WASHER FLAT
H100706



BOLT HEX
H100716



BOLT
H100718



SCREW PWH
H100742



To help with assembly we recommend sorting your hardware bags with the seven digit alpha-numeric number printed on the bags or by hardware type (i.e. bolts, nuts, etc.). Organizing your hardware will make assembly easier.

Hardware Identification

Hardware bags are printed with a seven digit alpha-numeric part number. During assembly you only need to reference the last three digits of the part number as noted in each step. This will make finding the correct hardware easier.

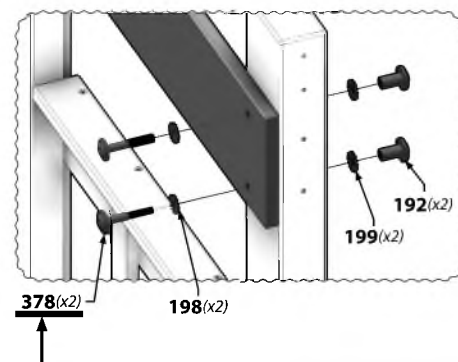
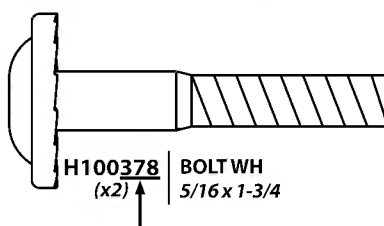

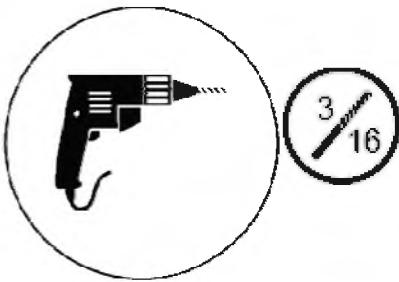
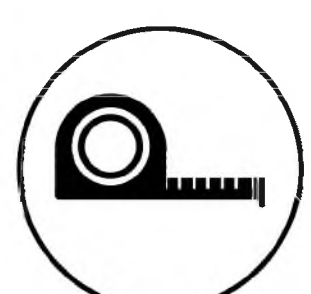
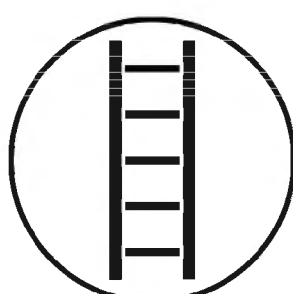
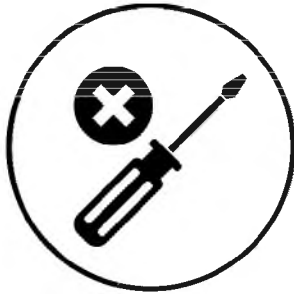
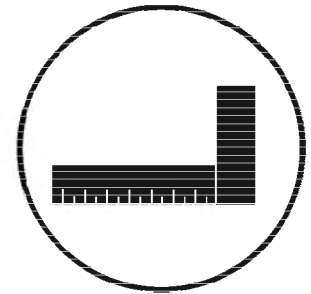
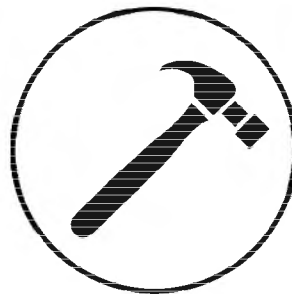
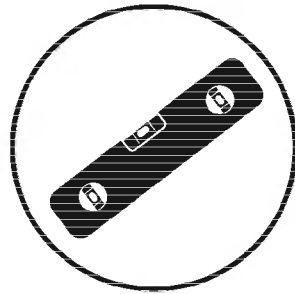
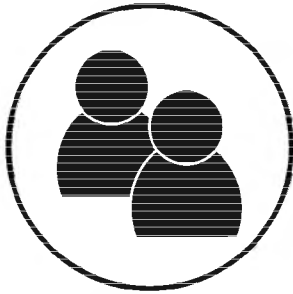

Icons and their uses you will see throughout this manual



You will need to make sure that your assembly is square before tightening your bolts.



When you see this icon you will need a socket wrench. The icons below show the size of attachments needed for assembly 1/2.



For proper assembly you will need to ensure that your structure is level before proceeding to the next step.

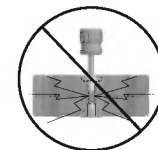

This icon warns you to not over tighten your bolts. This is to prevent structural damage and also splintering your wood.



Some steps in the assembly process will require an extra set of hands. Make sure you have a helper available.



This icon shows the size of an open ended wrench. Using the wrench as the fraction bar.

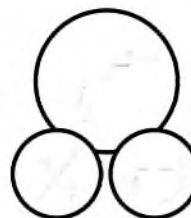

This icon will show you what drill attachments are needed. For this example you will need a Phillips head attachment and 3/8 socket.



It is critically important that you start with square and level footings, concrete pad or deck to attach your structure

- Pay close attention to the items needed for each step. Make sure you are using the correct hardware for each step. Using incorrect hardware may result in improper assembly
- Remember to double check for underground utilities and overhead electrical lines

Post mounts are provided with your structure which allows you to permanently install your structure to a pre-existing or new wood or concrete surface.

- The hardware to attach the post mounts to the structure is included.
- The hardware to mount the structure permanently to a concrete surface is included.
- The hardware to mount the structure permanently to a wood deck is NOT included and will need to be purchased separately. You must ensure there is ample structural support under the deck before permanently attaching.

Ground Dimension

EXAMPLE: 9'-10" (3m) x 9'-10" (3m) x 7'-11 3/8" (2.4m)

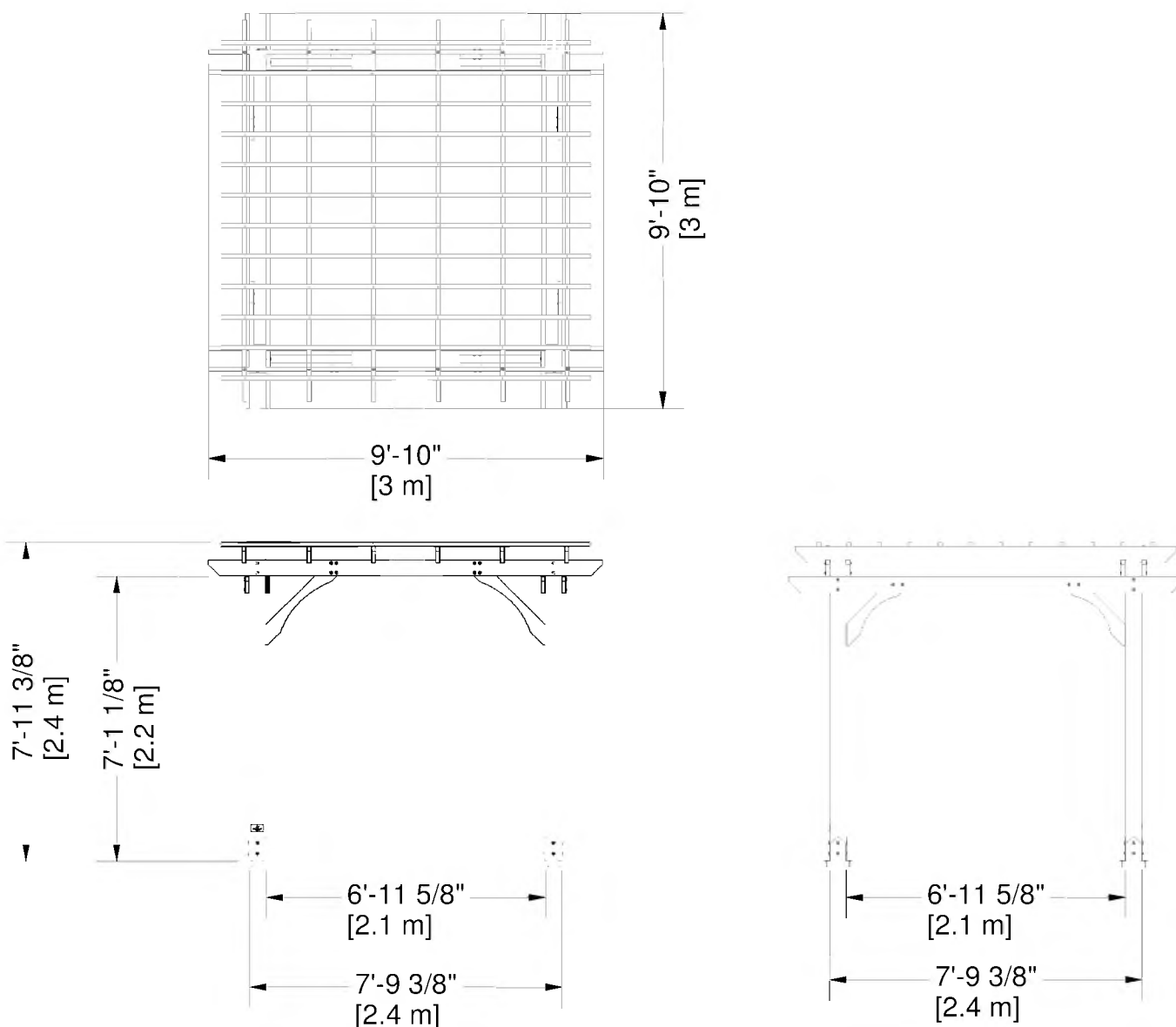



Wood Components (Not to Scale)



D3 | SLOTTED JOIST - W4L14052
(x6) | 1 1/4"x5"x114" (32x126x2896)



D4 | JOIST - W4L14053
(x2) | 1 1/4"x5"x118" (32x126x2998)



D5 | JOIST - W4L14054
(x2) | 1 1/4"x5"x118" (32x126x2998)



D7 | JOIST END - W4L14088
(x2) | 1 1/4"x5"x118" (32x126x2998)



D8 | LONG ANGLE BRACE - W4L14056
(x8) | 1 1/4"x5"x36 1/4" (32x126x922)

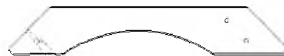

D9 | SHORT ANGLE BRACE - W4L14057
(x4) | 1 1/4"x5"x29 1/4" (32x126x743)



Wood Components (Not to Scale)



D10 | JOIST END - W4L14091
(x2) | 1 1/4"x5"x118" (32x126x2998)



V1 | PURLIN - W4L14092
(x12) | 1 1/4"x1 1/4"x46 1/4" (32x32x1175)

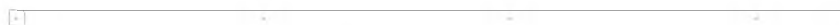

V2 | PURLIN - W4L14093
(x12) | 1 1/4"x1 1/4"x65 1/2" (32x32x1663)

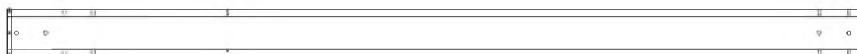

WP1 | PERGOLA POST - W2A03070
(x2) | 4 7/8"x4 7/8"x89 1/2" (125x125x2273)

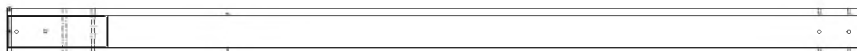

WP2 | PERGOLA POST - W2A03071
(x2) | 4 7/8"x4 7/8"x89 1/2" (125x125x2273)



Hardware Components

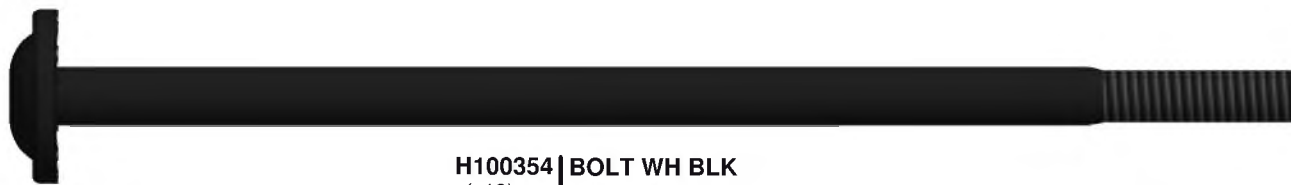

H100354 | BOLT WH BLK
(x18) | 5/16x6 1/2

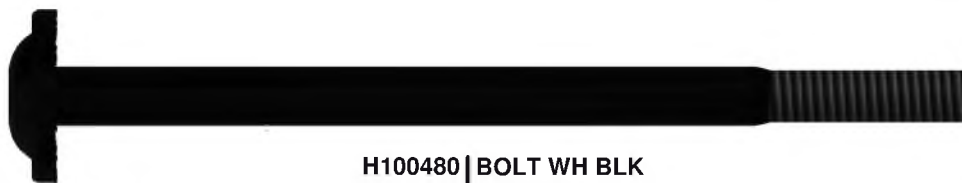

H100480 | BOLT WH BLK
(x9) | 5/16x4 3/4



H100764 | SCREW SETTER
(x1)



H100457 | BOLT WH BLK
(x42) | 5/16x2



H100193 | NUT BARREL WH BLK
(x18) | 5/16x1-1/2



H100192 | NUT BARREL WH BLK
(x50) | 5/16x7/8

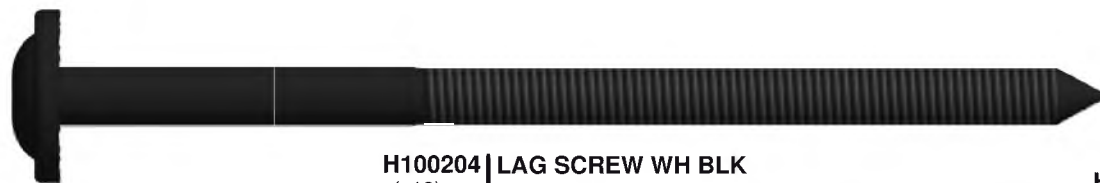

H100204 | LAG SCREW WH BLK
(x18) | 5/16x5 1/2



H100198 | WASHER LOCK EXT BLK
(x76) | 8x19



H100792 | LAG SCREW WH BLK
(x13) | 1/4x3



H100854 | LAG SCREW WH BLK
(x18) | 5/16x1



H100199 | WASHER LOCK EXT BLK
(x60) | 12x19



H100877 | SCREW TFH BLK
(x100) | 8x2-1/2



H100405 | WASHER LOCK EXT BLK
(x13) | 6x15



H100200 | SCREW PFH BLK
(x17) | 8x1 1/2



H100120 | SCREW CONCRETE ANCHOR
(x18) | 1/4x2



H100630 | WASHER FLAT BLK
(x17) | 8x19



H100392 | SCREW PWH BLK
(x6) | 8x3/4



Accessory Components (Not to Scale)



H100879 | TORX BIT
(x2) | T-20



H100147 | TORX BIT
(x2) | T-30



A100042 | TORX BIT
(x2) | T-40

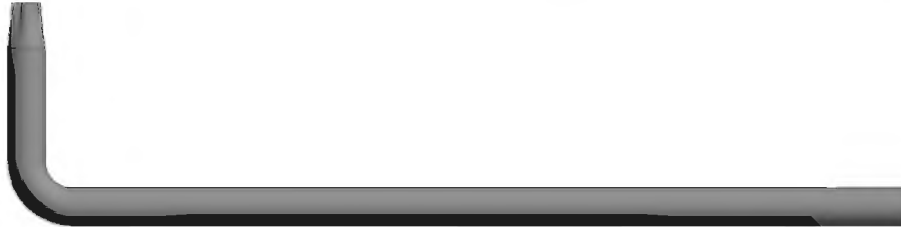

H100114 | TORX WRENCH
(x2) | T-30

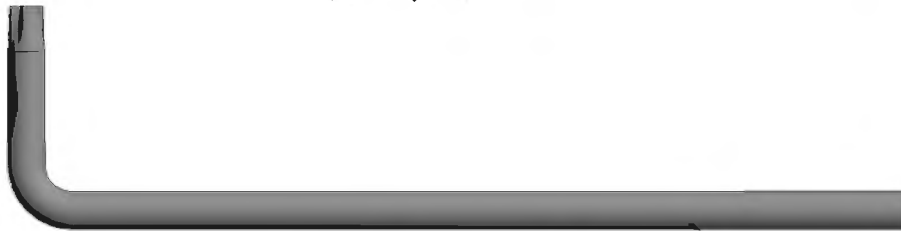

A100041 | TORX WRENCH
(x2) | T-40



A4M01157 | POST BRACKET
(x8)



A100314 | "A" REVISION TAG
(x1)



A4M01163 | KINGSLEY PARK TAG
(x1)



A4M01156 | POST ANCHOR BRACKET
(x8)

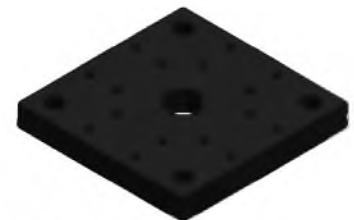

A6P00436 | 5x5 POST FOOT
(x4)



STEP 1



WP1 | PERGOLA POST - W2A03070
(x2) | 4 7/8"x4 7/8"x89 1/2" (125x125x2273)



WP2 | PERGOLA POST - W2A03071
(x2) | 4 7/8"x4 7/8"x89 1/2" (125x125x2273)

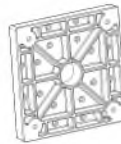

A6P00436 | 5x5 POST FOOT
(x4)



H100200 | SCREW PFH BLK
(x16) | 8x1-1/2

COMPLETE THIS STEP TWICE.



TIP:
FOR EASE OF ASSEMBLY WE RECOMMEND USING SAW HORSES FOR STEPS 1 THROUGH 4.

WP1 (x1)
PERGOLA POST

WP2 (x1)
PERGOLA POST

200 (x2)
SCREW PFH 8x1-1/2 BLK

436 (x2)
5x5 POST FOOT

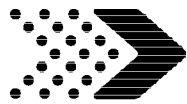

STEP 2

D4 | JOIST - W4L14053
(x2) | 1 1/4"x5"x118" (32x126x2998)

D5 | JOIST - W4L14054
(x2) | 1 1/4"x5"x118" (32x126x2998)

D9 | SHORT ANGLE BRACE - W4L14057
(x4) | 1 1/4"x5"x29 1/4" (32x126x743)

- H100354** | BOLT WH BLK
(x8) | 5/16x6 1/2
- H100457** | BOLT WH BLK
(x8) | 5/16x2
- H100792** | LAG SCREW WH BLK
(x4) | 1/4x3

- H100193** | NUT BARREL WH BLK
(x8) | 5/16x1-1/2
- H100192** | NUT BARREL WH BLK
(x8) | 5/16x7/8

- H100405** | WASHER LOCK EXT BLK
(x4) | 6x15
- H100198** | WASHER LOCK EXT BLK
(x16) | 8x19
- H100199** | WASHER LOCK EXT BLK
(x16) | 12x19

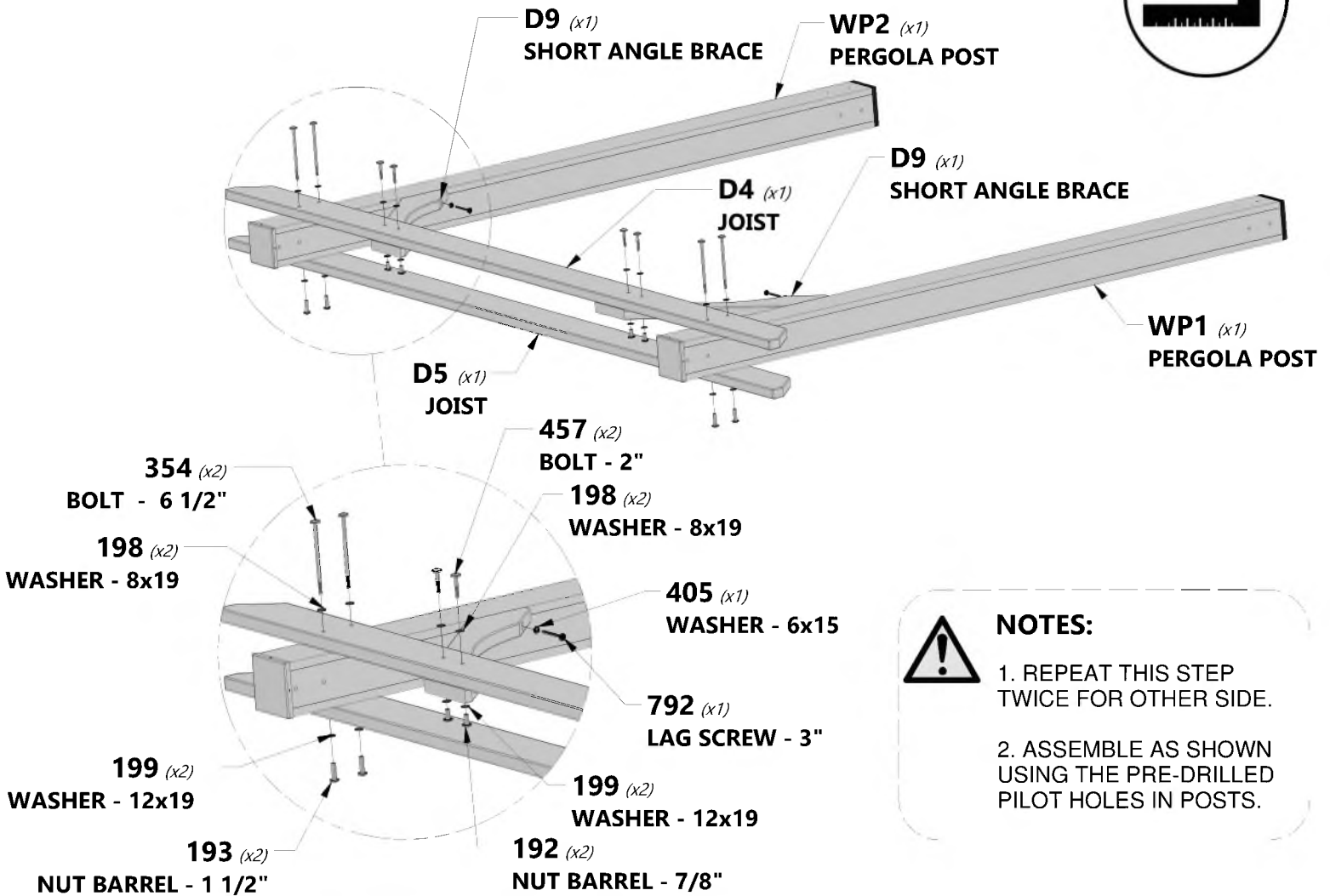
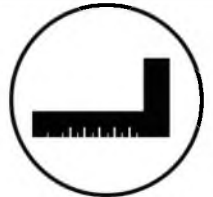

REPEAT ON OPPOSITE END



NOTES:

1. REPEAT THIS STEP TWICE FOR OTHER SIDE.
2. ASSEMBLE AS SHOWN USING THE PRE-DRILLED PILOT HOLES IN POSTS.



STEP 3



D10 | JOIST END - W4L14091
(x2) | 1 1/4"x5"x118" (32x126x2998)



D8 | LONG ANGLE BRACE - W4L14056
(x4) | 1 1/4"x5"x36 1/4" (32x126x922)



H100457 | BOLT WH BLK
(x16) | 5/16x2



H100192 | NUT BARREL WH BLK
(x16) | 5/16x7/8



H100198 | WASHER LOCK EXT BLK
(x16) | 8x19



H100199 | WASHER LOCK EXT BLK
(x16) | 12x19



NOTES:

REPEAT STEP TO COMPLETE TWO INNER JOIST ASSEMBLIES.

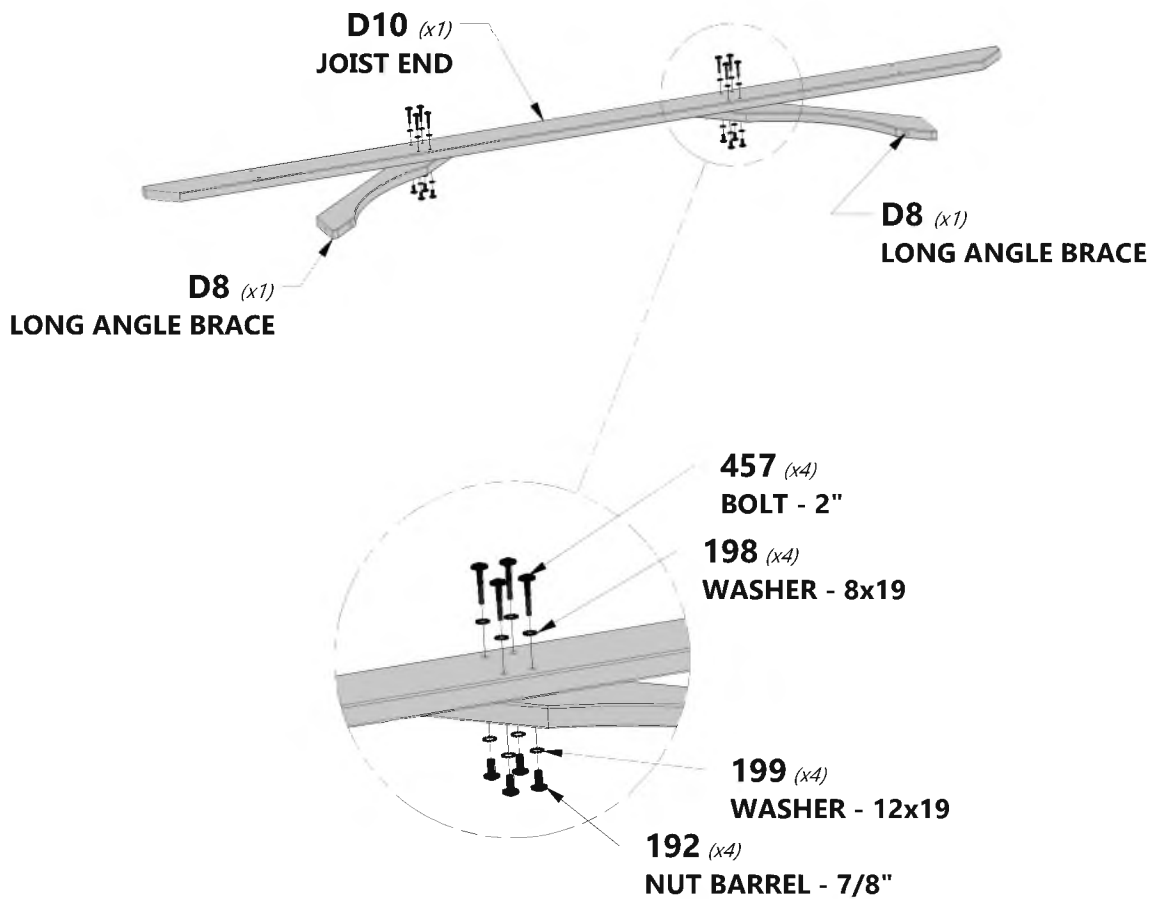

REPEAT ON OPPOSITE END



STEP 4

D7 | JOIST END - W4L14088
(x2) | 1 1/4"x5"x118" (32x126x2998)

D8 | LONG ANGLE BRACE - W4L14056
(x4) | 1 1/4"x5"x36 1/4" (32x126x922)



H100457 | BOLT WH BLK
(x16) | 5/16x2



H100192 | NUT BARREL WH BLK
(x16) | 5/16x7/8



H100198 | WASHER LOCK EXT BLK
(x16) | 8x19



H100199 | WASHER LOCK EXT BLK
(x16) | 12x19



NOTES:
REPEAT STEP TO COMPLETE TWO
OUTER JOIST ASSEMBLIES.

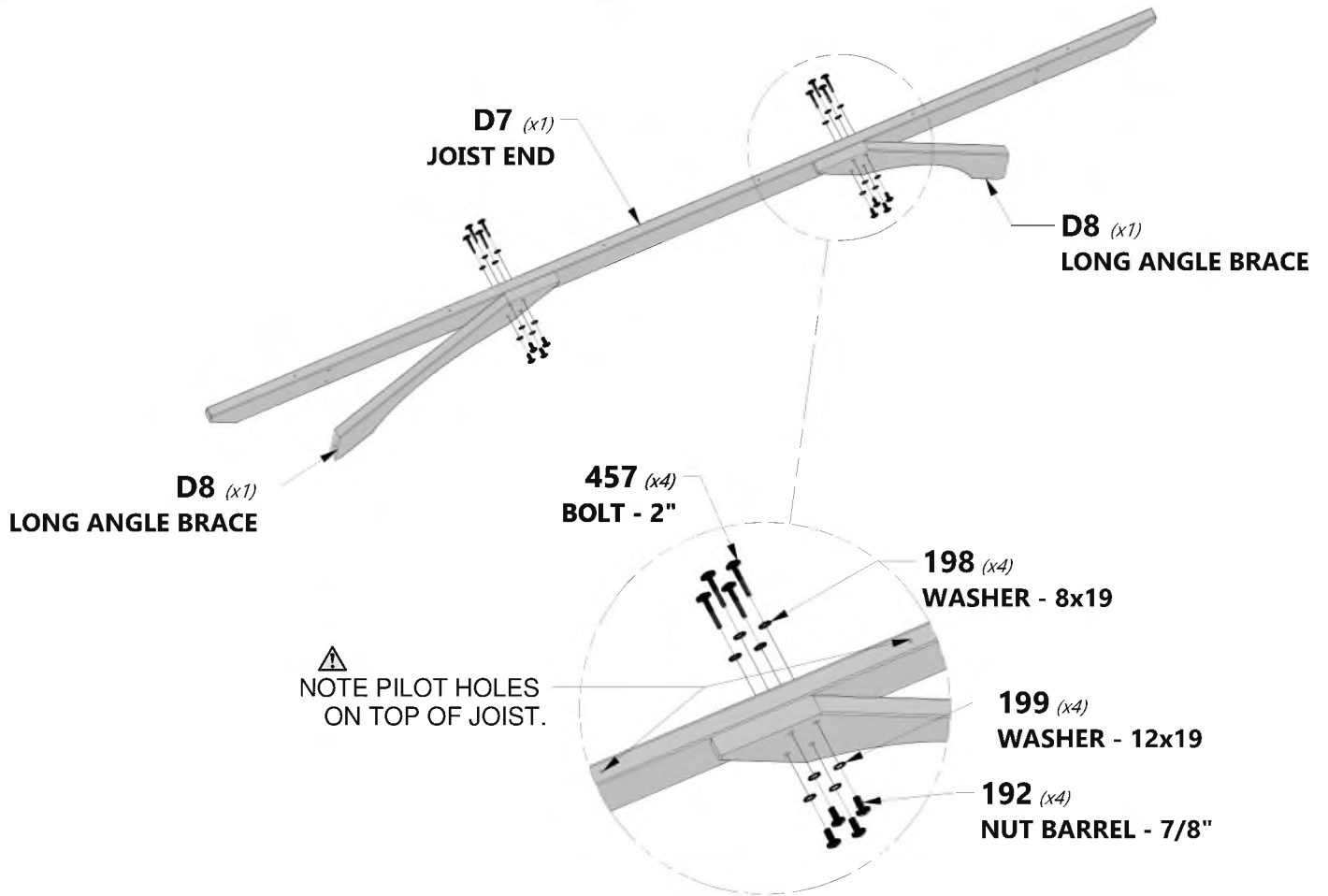

REPEAT ON OPPOSITE END.



STEP 5



(x2) UPRIGHT ASSEMBLY FROM PREVIOUS STEPS



(x2) INNER JOIST ASSEMBLY FROM PREVIOUS STEPS



(x2) OUTER JOIST ASSEMBLY FROM PREVIOUS STEPS



H100354 | BOLT WH BLK
(x8) | 5/16x6 1/2



H100405 | WASHER LOCK EXT BLK
(x8) | 6x15



H100792 | LAG SCREW WH BLK
(x8) | 1/4x3



H100198 | WASHER LOCK EXT BLK
(x8) | 8x19



H100199 | WASHER LOCK EXT BLK
(x8) | 12x19



H100193 | NUT BARREL WH BLK
(x8) | 5/16x1-1/2

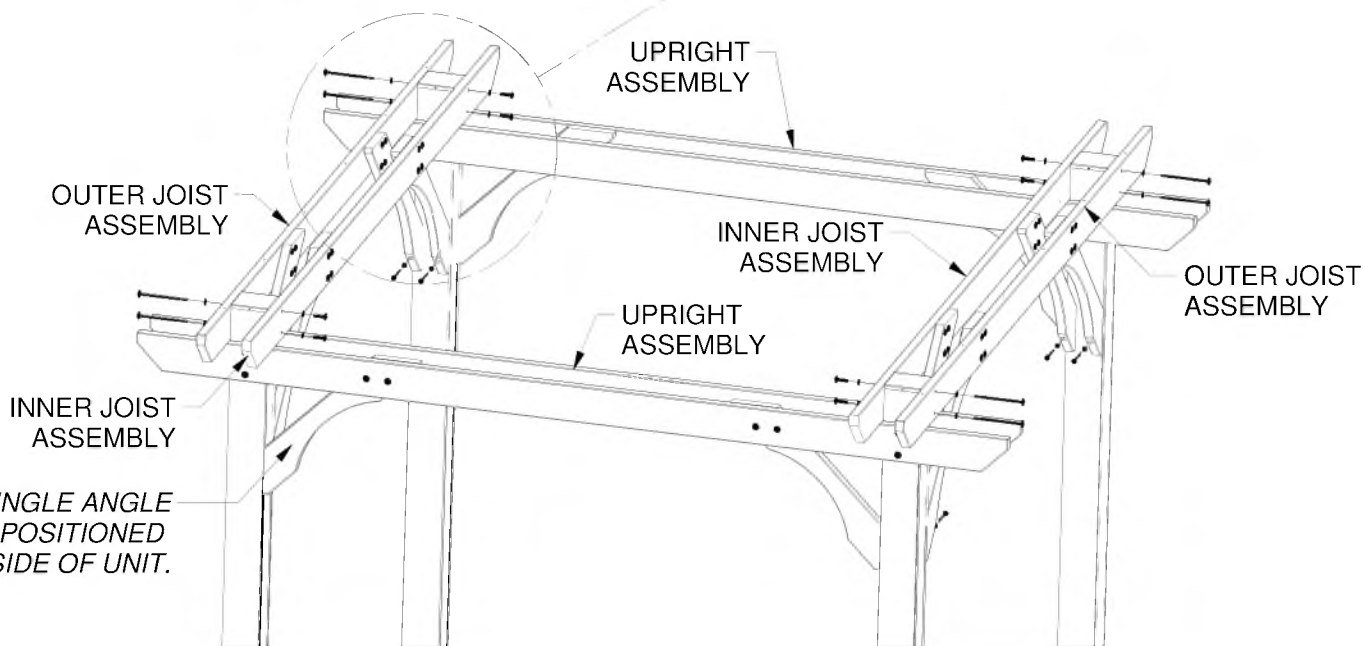
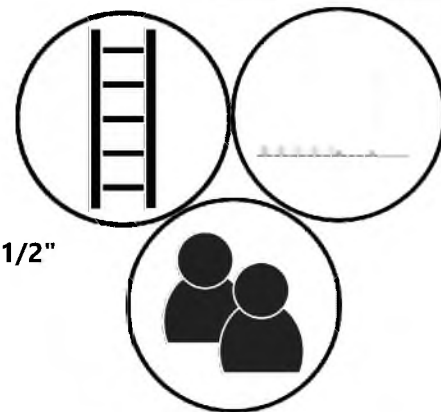
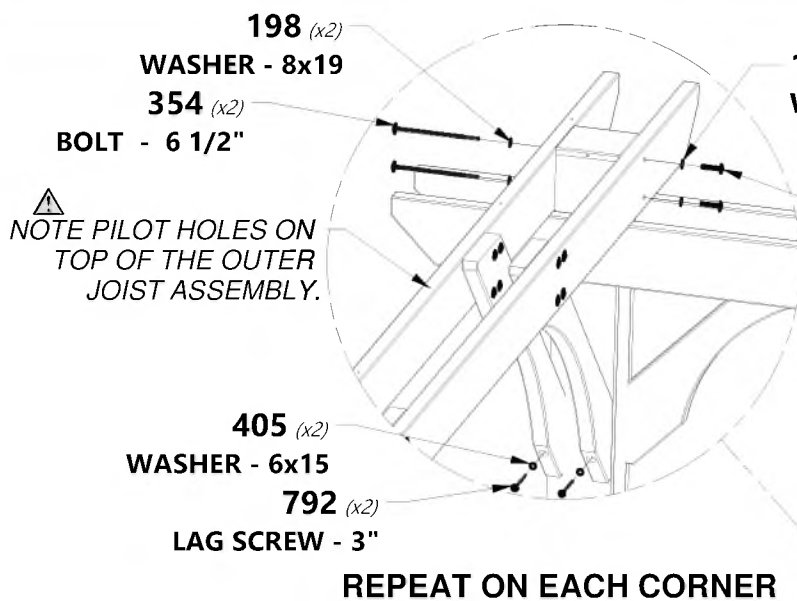



STEP 6

D3 | SLOTTED JOIST - W4L14052
(x6) | 1 1/4"x5"x114" (32x126x2896)



H100204 | LAG SCREW WH BLK
(x12) | 5/16x5 1/2



H100198 | WASHER LOCK EXT BLK
(x12) | 8x19



NOTES:

LOCATE AND USE PILOT HOLES IN THE OUTER JOIST TO MOUNT D3 BOARDS AS SHOWN.

REPEAT ON OPPOSITE END AND ON ALL JOIST



204 (x1)
LAG SCREW - 5 1/2"

198 (x1)
WASHER - 8x19

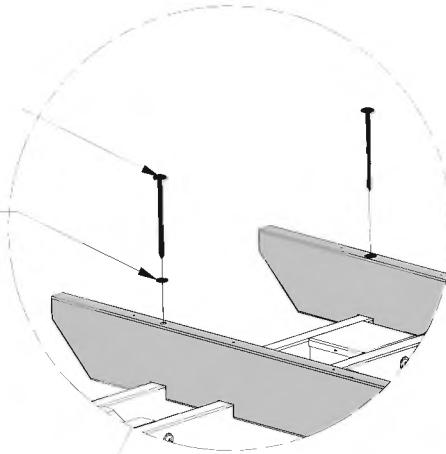

D3 (x8)
SLOTTED JOIST

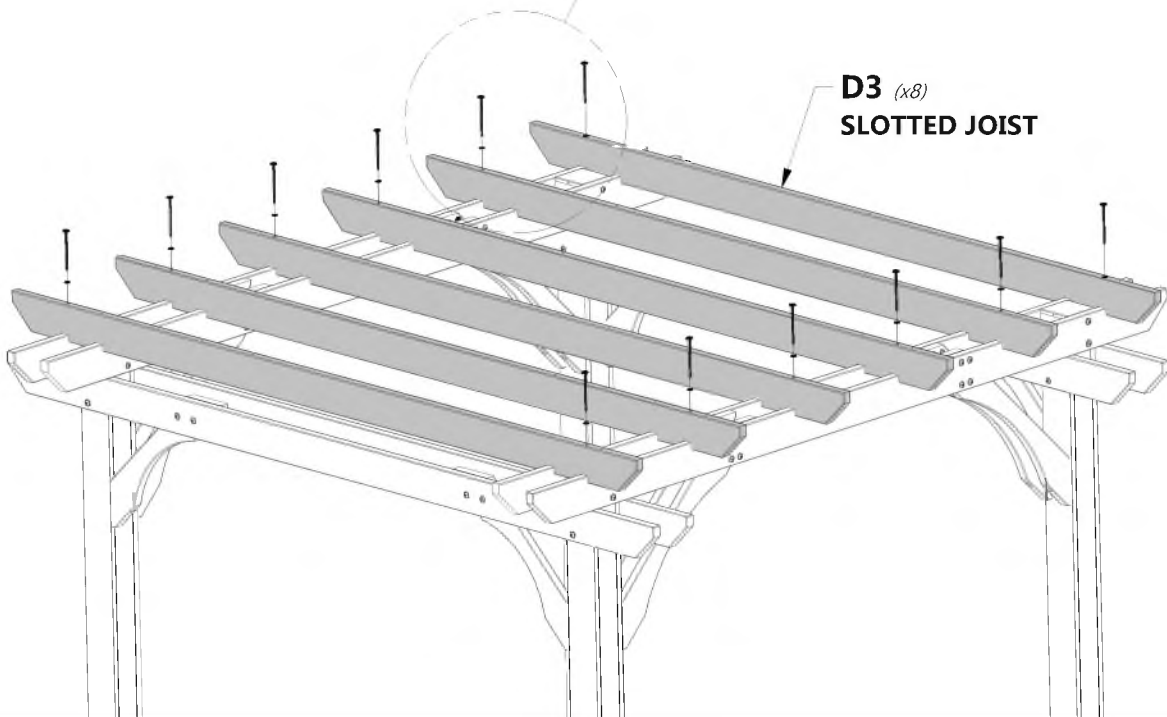



STEP 7

V1 | PURLIN - W4L14092
(x12) | 1 1/4"x1 1/4"x46 1/4" (32x32x1175)

V2 | PURLIN - W4L14093
(x12) | 1 1/4"x1 1/4"x65 1/2" (32x32x1663)

H100877 | SCREW TFH BLK
(x72) | 8x2-1/2

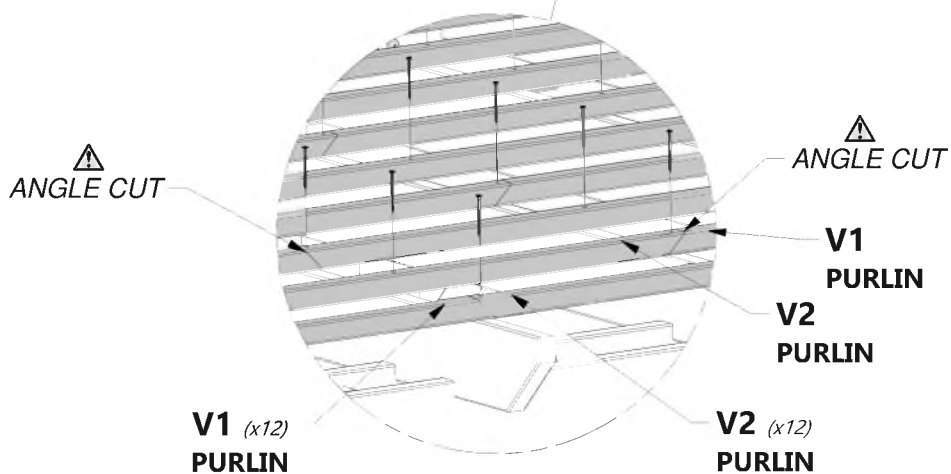
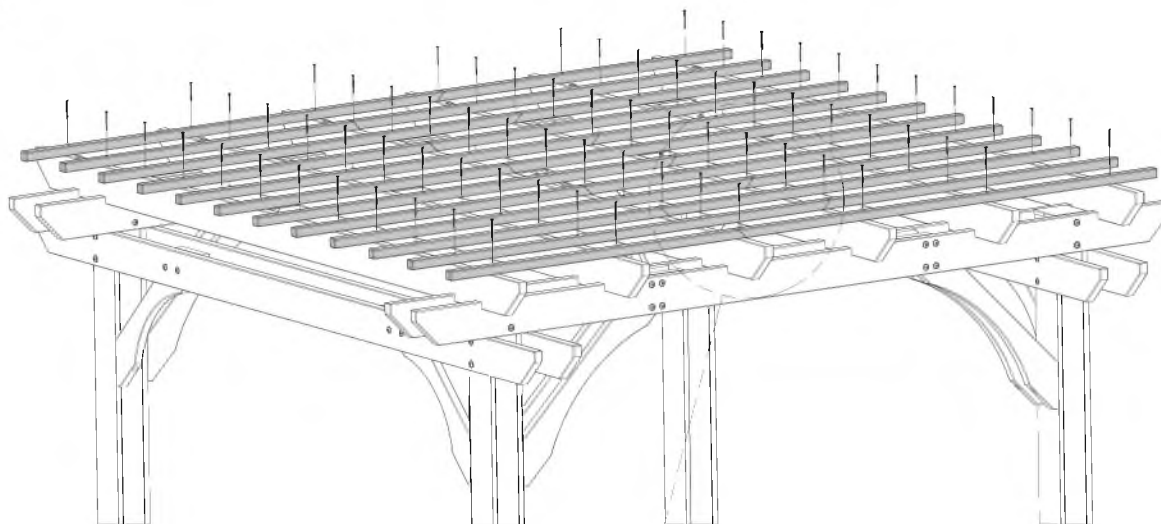
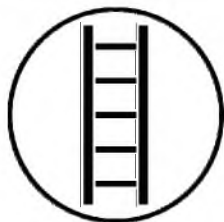

NOTES:

ASSEMBLE V1 & V2 BOARDS BY ALTERNATING THEM AS YOU WORK ACROSS THE JOIST BOARDS. AS SHOWN THE ANGLE CUT IN THE V1 & V2 BOARDS SHOULD ALTERNATE WHICH JOIST THEY LAND ON WHEN ASSEMBLED.



STEP 8

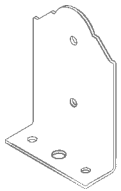

A4M01156
(x8) | **POST ANCHOR BRACKET**



A4M01157
(x8) | **POST BRACKET**



H100854
(x16) | **LAG SCREW WH BLK**
5/16x1



H100192
(x8) | **NUT BARREL WH BLK**
5/16x7/8



H100480
(x8) | **BOLT WH BLK**
5/16x4 3/4

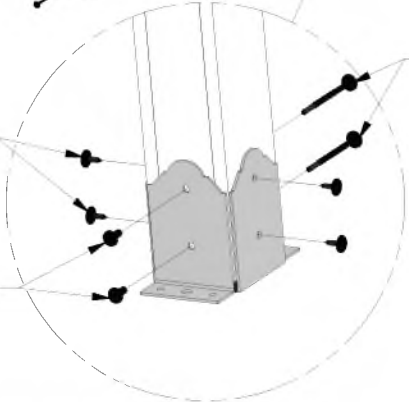
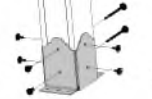
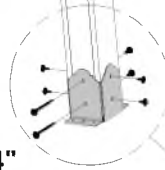
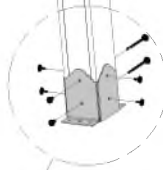
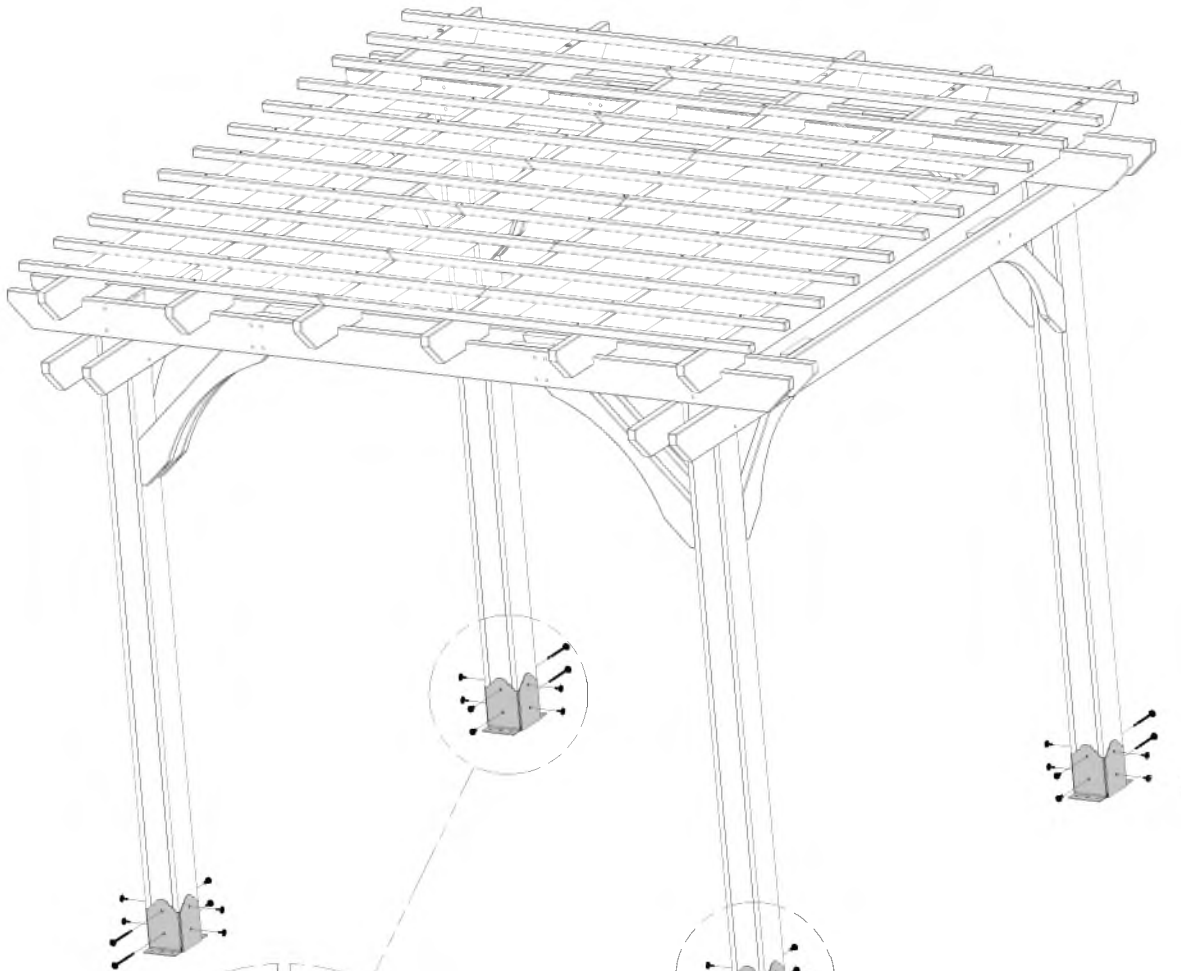

471 *(x16)*
LAG SCREW - 1"

192 *(x8)*
NUT BARREL - 7/8"

480 *(x8)*
BOLT - 4 3/4"

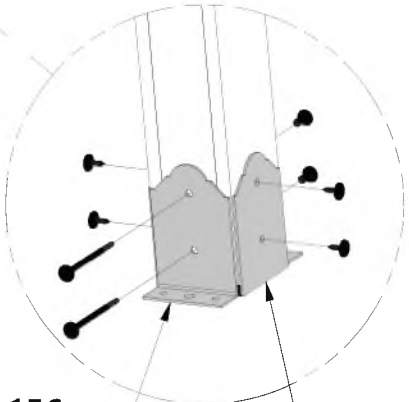

156 *(x8)*
POST ANCHOR BRACKET

157 *(x8)*
POST BRACKET

NOTE ABOVE THAT BOLT AND BARREL NUT ARE USED ON ANCHOR BRACKETS AND LAG SCREWS ON PLAIN POST BRACKETS.



STEP 9



A4M01163 | KINGSLEY PARK TAG
(x1)



A100314 | "A" REVISION TAG
(x1)



H100392 | SCREW PWH BLK
(x6) | 8x3/4

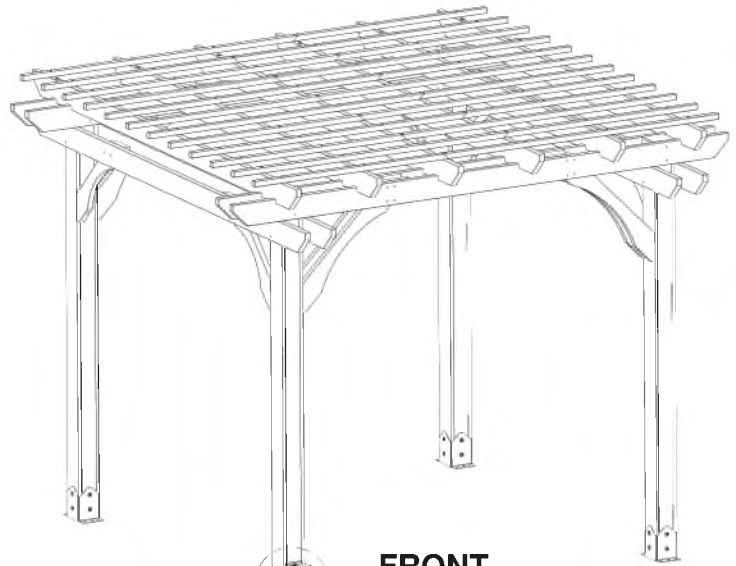

FRONT

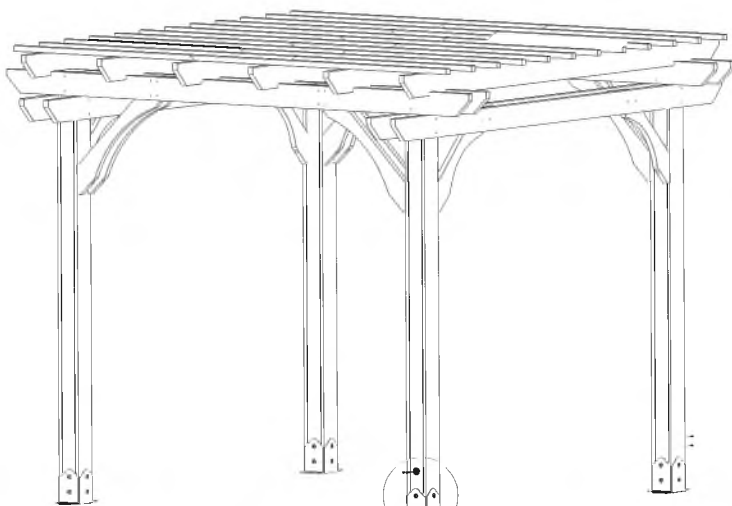

REAR

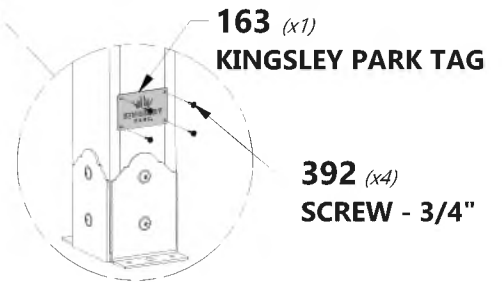

163 *(x1)*
KINGSLEY PARK TAG

392 *(x4)*
SCREW - 3/4"

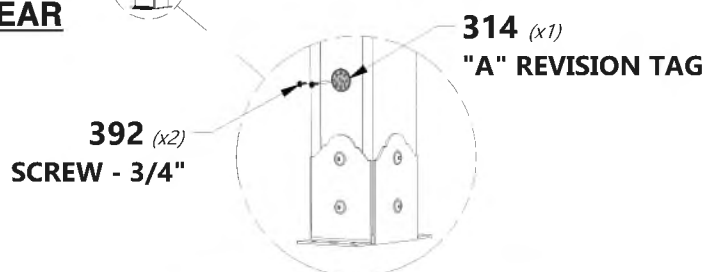

314 *(x1)*
"A" REVISION TAG

392 *(x2)*
SCREW - 3/4"



STEP 10



H100120 | SCREW CONCRETE ANCHOR
(x16) | 1/4x2



H100630 | WASHER FLAT BLK
(x16) | 8x19



NOTES:

MANUFACTURER RECOMMENDS INSTALLATION ON A CONCRETE SURFACE OR CONCRETE POST PADS. SEE BELOW.

FOR INSTALLATION ON WOOD DECK, YOU MUST ENSURE THERE IS AMPLE STRUCTURAL SUPPORT UNDER DECK.

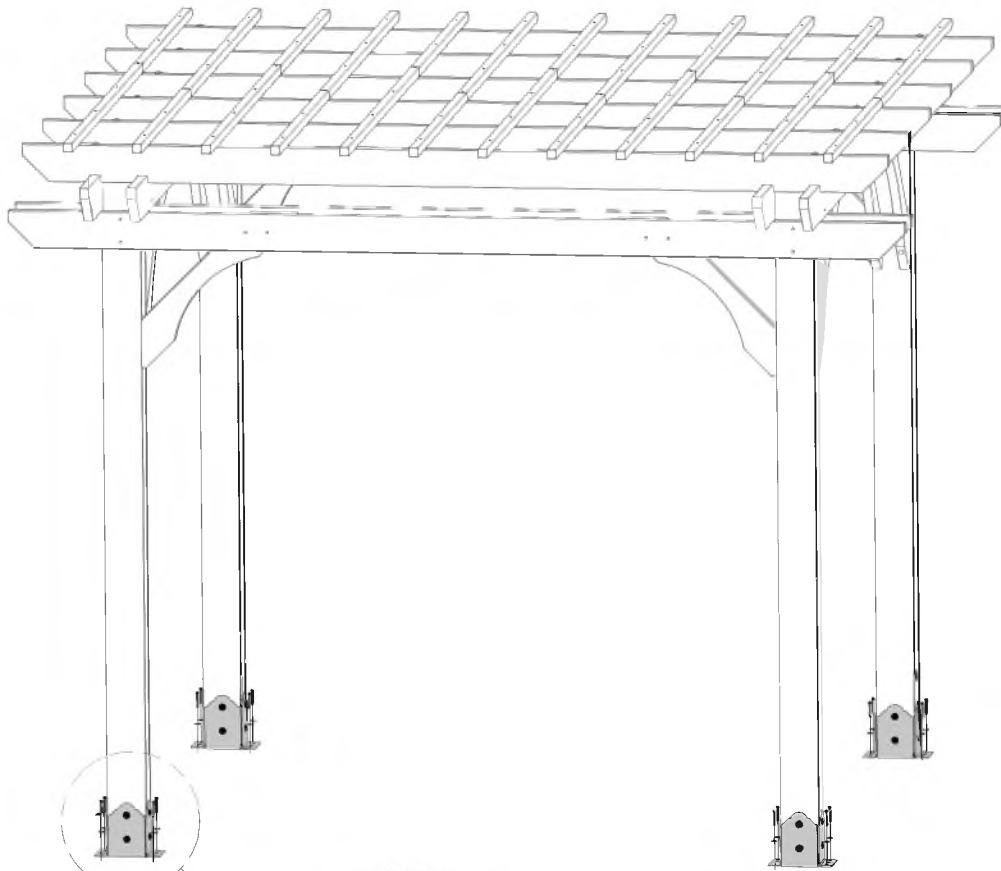

120 (x16)
SCREW - 2"

630 (x16)
WASHER - 8x19



NOTES:

PRE-DRILL HOLES FOR CONCRETE ANCHORS USING A 3/16" CONCRETE DRILL BIT.



PowerPort™

Model # 9205413
Wood Post Mounting Instructions



PowerPort.

MANUFACTURED BY:
Backyard Discovery
3305 Airport Drive
Pittsburg, KS 66762
800-856-4445

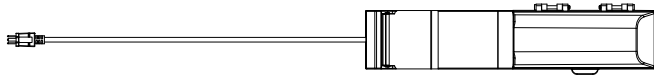

9205413 | ELECTRICAL ENCLOSURE
(x1)



H100966 | SCREW RAISED HEAD
(x4) | 8x1 1/2

WARNING: Cancer and Reproductive Harm - www.P65Warnings.ca.gov

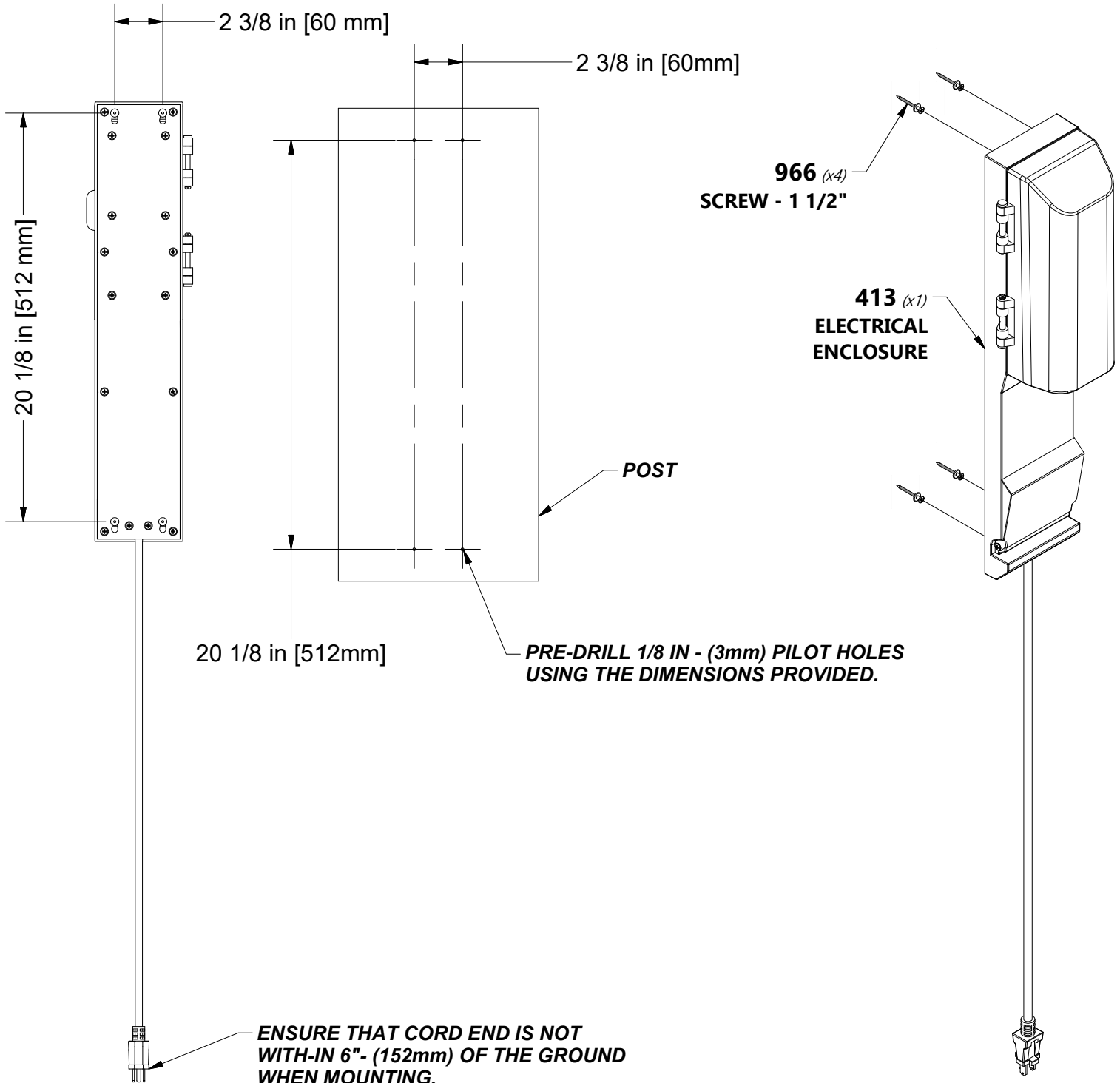



A4M01292 | MOUNTING BRACKET
(x2)

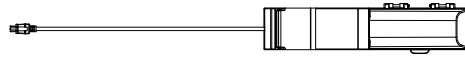

9205413 | ELECTRICAL ENCLOSURE
(x1)



H100746 | SCREW TAPPING
(x4) | 10x1 1/4"

! WARNING: Cancer and Reproductive Harm - www.P65Warnings.ca.gov

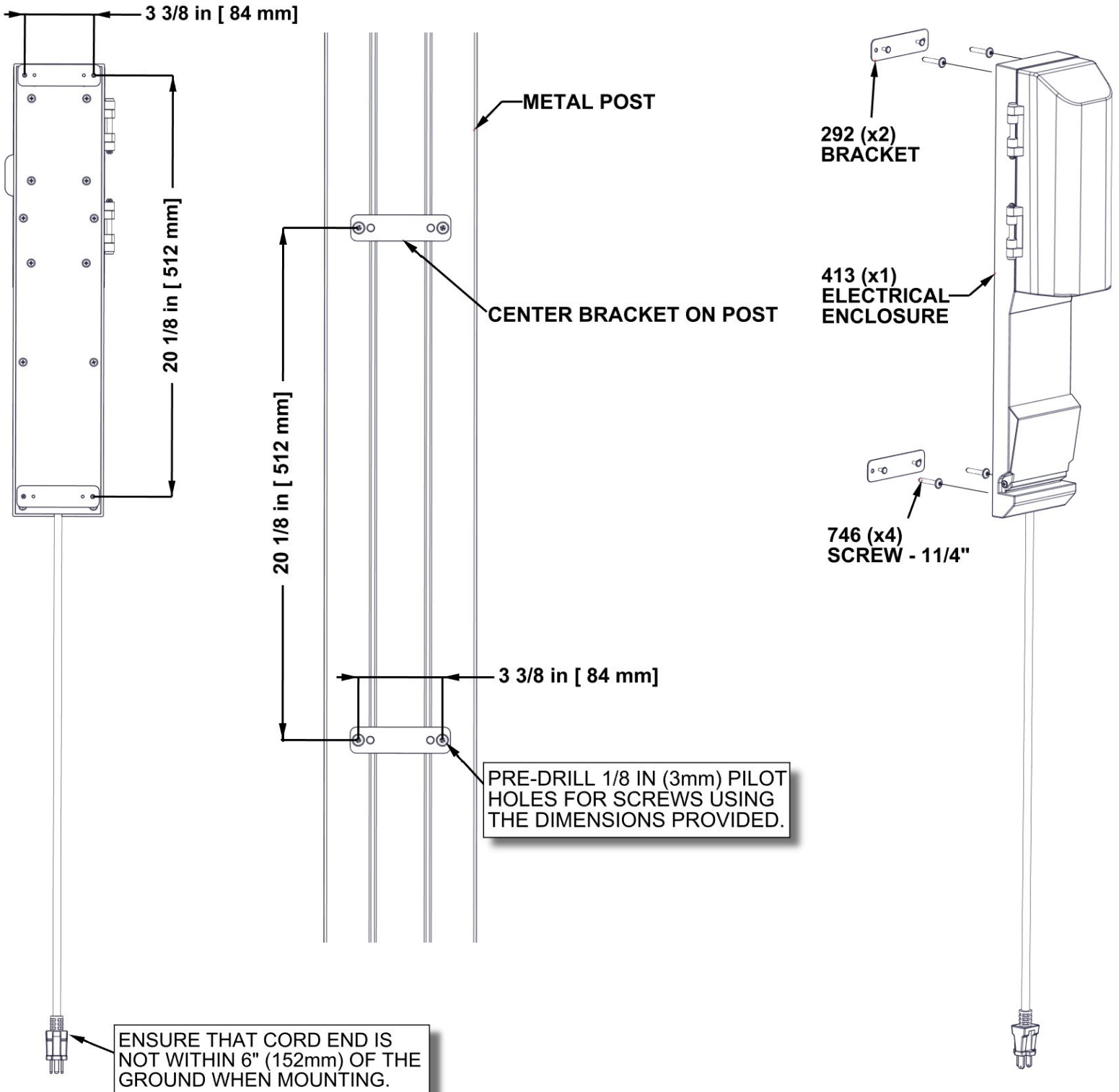

FCC MARKING:

This device complies with part 15 of the FCC Rules. Operation is subject to the following two conditions: (1) This device may not cause harmful interference, and (2) this device must accept any interference received, including interference that may cause undesired operation.

FCC INSTRUCTIONS:

CAUTION: Changes or modifications not expressly approved by the party responsible for compliance could void the user's authority to operate the equipment.

For a Class B digital device or peripheral, the instructions furnished the user shall include the following or similar statement, placed in a prominent location in the text of the manual:

Note: This equipment has been tested and found to comply with the limits for a Class B digital device, pursuant to part 15 of the FCC Rules. These limits are designed to provide reasonable protection against harmful interference in a residential installation. This equipment generates, uses and can radiate radio frequency energy and, if not installed and used in accordance with the instructions, may cause harmful interference to radio communications. However, there is no guarantee that interference will not occur in a particular installation. If this equipment does cause harmful interference to radio or television reception, which can be determined by turning the equipment off and on, the user is encouraged to try to correct the interference by one or more of the following measures:

- Reorient or relocate the receiving antenna.
- Increase the separation between the equipment and receiver.
- Connect the equipment into an outlet on a circuit different from that to which the receiver is connected.
- Consult the dealer or an experienced radio/TV technician for help.



PowerPort™

Model # 9205413
Wood Post Mounting Instructions



PowerPort.

MANUFACTURED BY:
Backyard Discovery
3305 Airport Drive
Pittsburg, KS 66762
800-856-4445

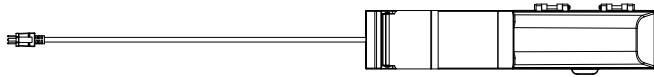

9205413 | ELECTRICAL ENCLOSURE
(x1)



H100966 | SCREW RAISED HEAD
(x4) | 8x1 1/2

WARNING: Cancer and Reproductive Harm - www.P65Warnings.ca.gov

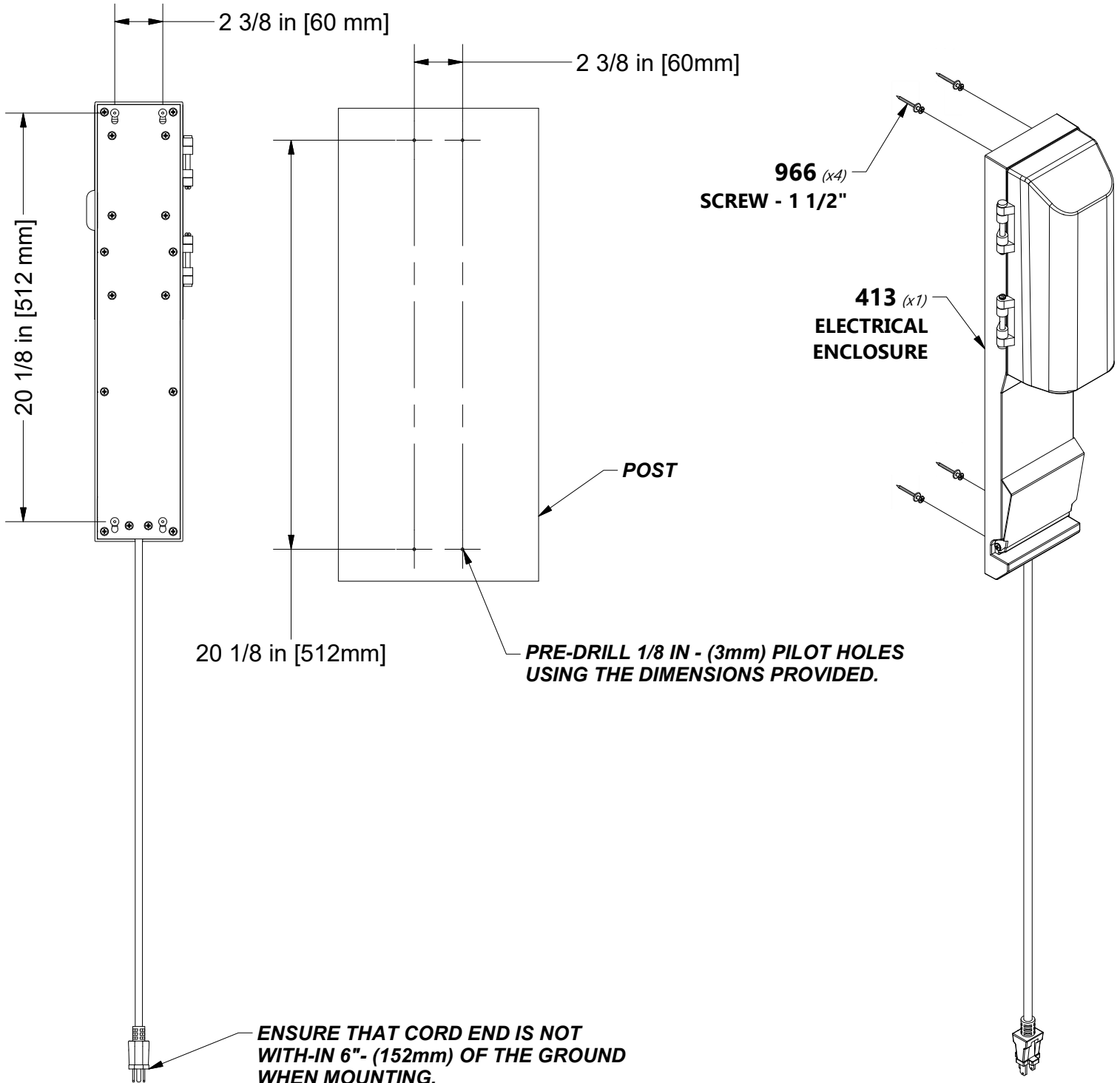



A4M01292 | MOUNTING BRACKET
(x2)

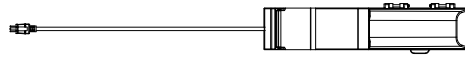

9205413 | ELECTRICAL ENCLOSURE
(x1)



H100746 | SCREW TAPPING
(x4) | 10x1 1/4"

WARNING: Cancer and Reproductive Harm - www.P65Warnings.ca.gov

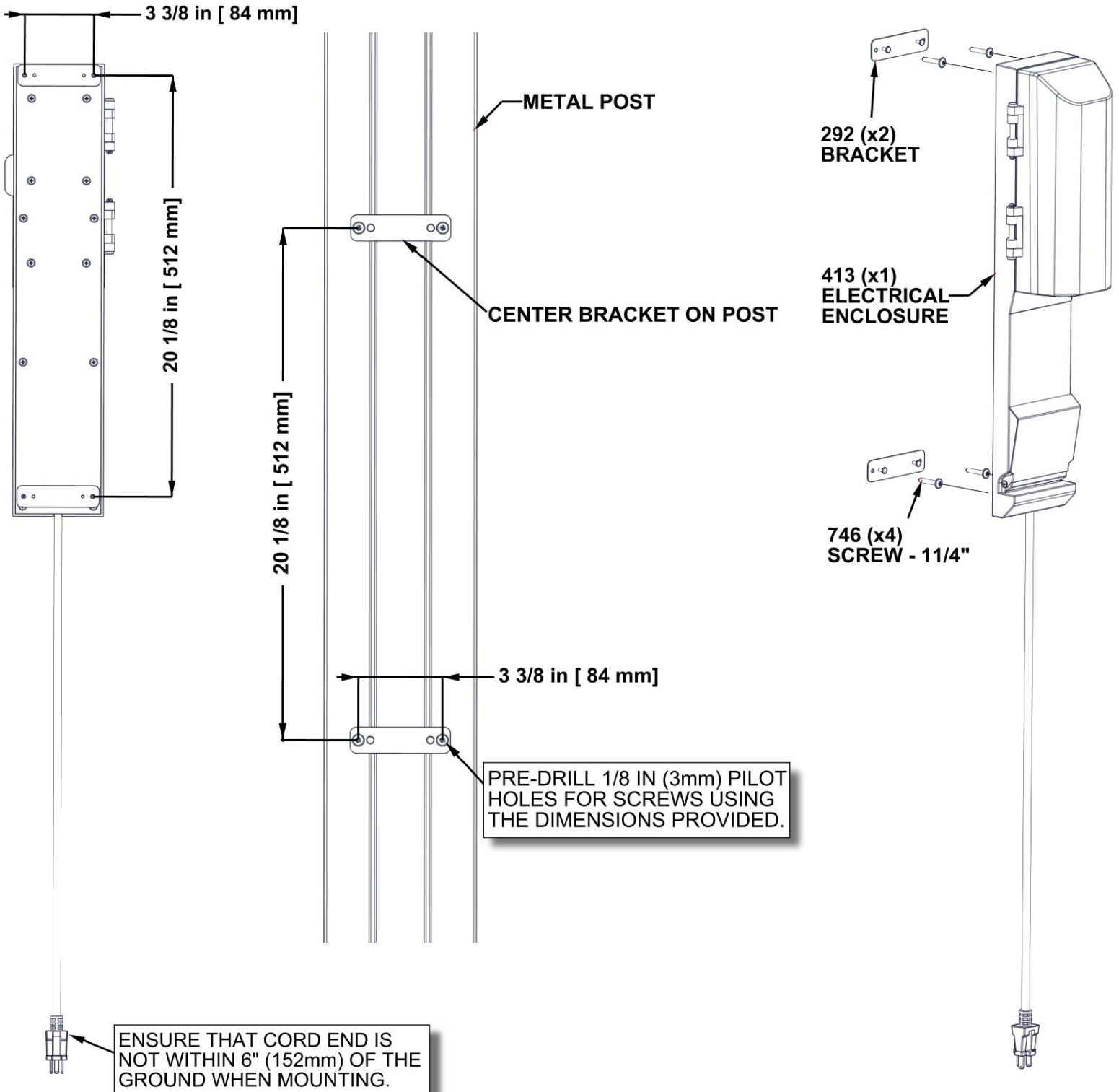

FCC MARKING:

This device complies with part 15 of the FCC Rules. Operation is subject to the following two conditions: (1) This device may not cause harmful interference, and (2) this device must accept any interference received, including interference that may cause undesired operation.

FCC INSTRUCTIONS:

CAUTION: Changes or modifications not expressly approved by the party responsible for compliance could void the user's authority to operate the equipment.

For a Class B digital device or peripheral, the instructions furnished the user shall include the following or similar statement, placed in a prominent location in the text of the manual:

Note: This equipment has been tested and found to comply with the limits for a Class B digital device, pursuant to part 15 of the FCC Rules. These limits are designed to provide reasonable protection against harmful interference in a residential installation. This equipment generates, uses and can radiate radio frequency energy and, if not installed and used in accordance with the instructions, may cause harmful interference to radio communications. However, there is no guarantee that interference will not occur in a particular installation. If this equipment does cause harmful interference to radio or television reception, which can be determined by turning the equipment off and on, the user is encouraged to try to correct the interference by one or more of the following measures:

- Reorient or relocate the receiving antenna.
- Increase the separation between the equipment and receiver.
- Connect the equipment into an outlet on a circuit different from that to which the receiver is connected.
- Consult the dealer or an experienced radio/TV technician for help.